



OIL PRESSURE FOR ROTAX ENGINES 912/914 WITH 4..20mA Sender. Diameter 80mm. PSI. IM-544

Preface

The IM-544 instruments have been designed especially to measure the Oil Pressure in Rotax® engines 912/914.

The IM-545 is available in 80 mm size.

The instruments have been designed to work with both 12V and 24V systems.

The minimum instrumentation requirements for BRP ROTAX® four stroke engines include a gauge for continuous Oil Pressure monitorization.



General Information

ATTENTION : The IM-544 has not undergone any safety or durability examination to Civil Aviation standards but does incorporate the latest technical development and has been thoroughly tested. Despite the Oil Pressure gauge being a precision instrument, false indication or misinterpretation of data could occur. By utilizing this instrument the user acknowledges the possible danger and responsibility for all risks.

State of receipt

- Instruments packed in a plastic bag
- 4 attachment screws
- 3 Loose plugs

Technical data

Case:	Plastic
Weight:	200g
Suitable for:	Rotax 912/914 with 4..20mA Sender
Power Supply:	10..30VDC
Power Current:	0.1 Amp. Max.
Scale:	0..120 PSI
Subdivision scale:	2 PSI
Max. Deviation:	2%
Dimensions:	See sketch
Calibration:	Calibrated by the manufacturer prior to shipment.

*Please refer to the updated User Manual of your engine BRP-ROTAX® engine for the operational limits

Installation Instructions

- Install instruments in pilot's field of vision, free from vibration and glare.
- Protect the instruments against dampness and any kind of gasoline or acid.
- Pay attention to installation dimensions
- Wiring has to be carried out with good quality plastic-sheathed cable.
- When routing cables, prevent possible damage to cables from heat, vibration, shearing or crushing.
- Install a breaker or fuse of 1 Amp.

Instruments Terminals

- 1) (+) Red wire to positive terminal of battery.
- 2) (-) Black wire to negative terminal of battery.
- 3) Input to the Oil Pressure Sender.
- 4) Factory calibration input.

Wire Connections

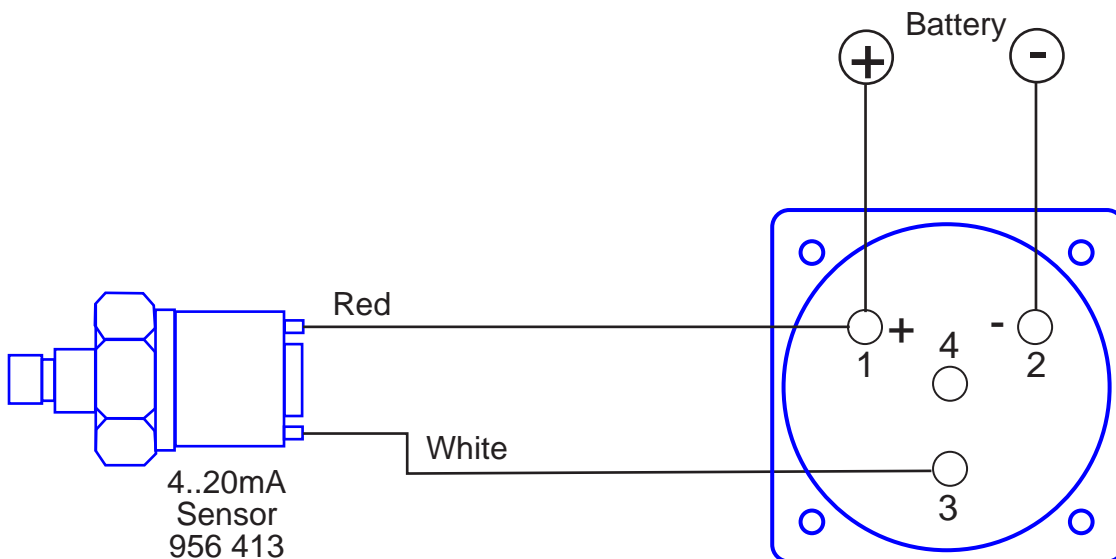

Dimensions

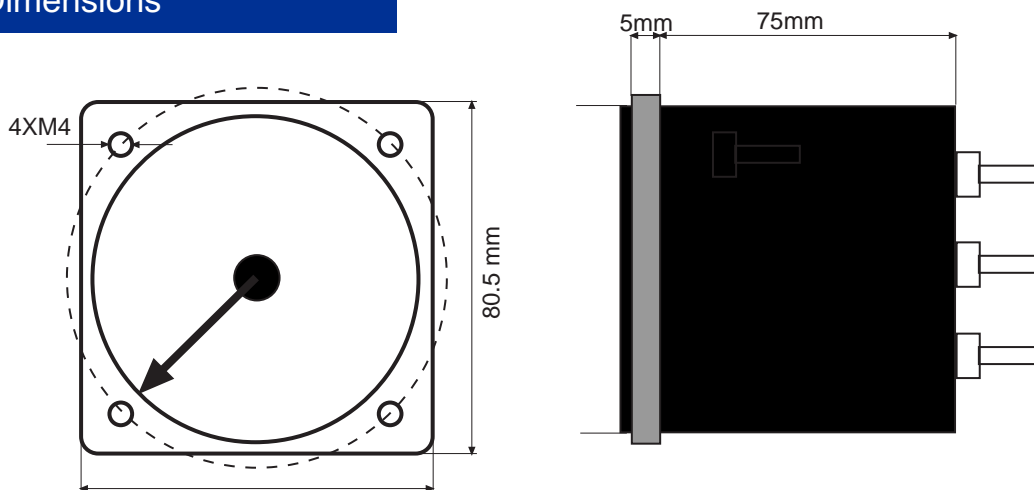

Notes

- With the engine stoped, the OIL Pressure is 0 PSI. With 0 PSI, the needle go to full scale.
- If the sensor malfunctions or the cable is loose, the needle go to full scale

Test & Calibration

The simplest method to check the instrument and probe is with compressed air. Apply compressed air to the probe, and check that the pressure gauge needle of the compressor, indicates the same as the instrument.

